

技术参数:

- 材料: 压铸铝
- 表面处理: 粉末喷涂
- 颜色: RAL 9005 (黑色)
- 温度范围: -40℃ - +125℃
- 防护等级: IP68/IP69K
- 出线方向: 顶出线
- 出线孔数: 1
- 螺纹规格: M32

Technical specification:

- Material: aluminium die-cast
- Surface: powder-coated
- Colour: RAL 9005(black)
- Temperature range: -40℃ - +125℃
- Degree of protection: IP68/IP69K
- Cable entry: top entry
- No. of cable entries: 1
- Thread size: M32

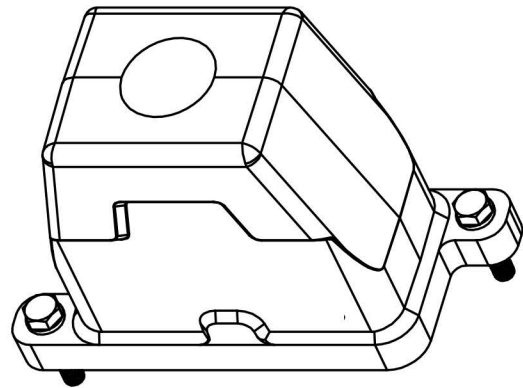

						表面处理 Finish	-			图号 Drawing No.	-	
						材料 Material	-			产品代号 Part Code	H10BPR-TGH-M32	
标记 Mark	处数 Number	变更描述/Description			签名 Signature	日期 Date	比例 Scale	版本 REV.	重量 Weight	数量 Qty.	产品料号 Part No.	1920100132
绘图 Drawn		姓名/Name	日期/Date	姓名/Name	日期/Date	1:2	V1.0	500g	-	产品名称 Part Name	-	
审核 Checked			18.10.2010	标准化 Stand.	-							
工艺 Process			18.10.2010	批准 Approved								
						⊕	⊖	All Dimensions in mm Original Size DIN A 4			HDXBSCN 浙江西霸士电气有限公司	